

SÖRF KİMYA SAN. TİC. LTD. ŞTİ.

HAVACILIK KİMYASALLARI

AVIATION CHEMICALS

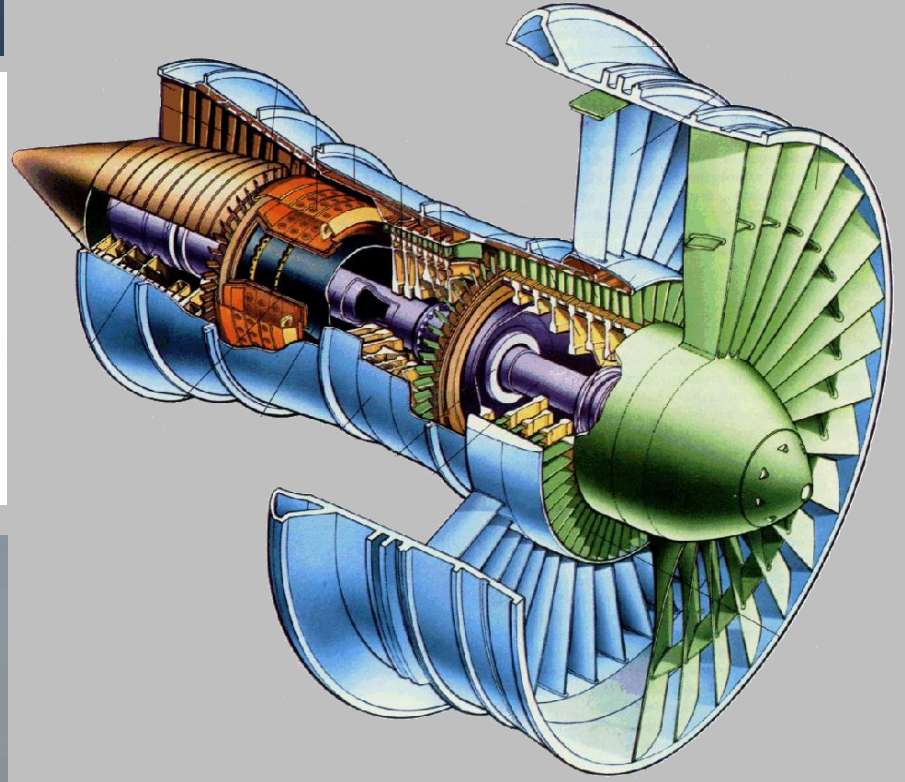

SÖRF KİMYA

İNŞ. TAAH. TUR. GIDA ve TEMİZLİK ÜR.
SAN. TİC. İTH. İHR. LTD. ŞTİ.



SÖRF TOURISM FOOD CHEMICAL CONSTRUCTION SAN.TİC.LTD.ŞTİ. Was founded in 2001 in Izmir. Hotel several years between 2001-2011 in the Republic of Turkey, Hospital, School, Factory and the need for cleaning products with products that meet their business has been produced.

Since 2011 Industrial Maintenance Chemicals, Water Treatment Chemicals for maintenance chemicals and aerospace sector is concentrated in the production.

Since 2011, the product catalog of Defense Industry Undersecretariat (www.ssm.gov.tr/katalog2007/data/surfkimya/firmaeng.html) has taken its place among the suppliers.

March 7, 2011 in the International Aircraft and Aircraft Parts Manufacturer companies (Boeing, Airbus and DOUGLAS) SM authorized to test the name given to the accreditation authority of the INC from Jen EX APC CLEAN product called Holiday Rentals Outside washing and approval can be used on internal cleaning is taken.

At the same time private Airlines has been started with interviews and field work. As a result of field work IZ-AIR, MY TECHNIC, ATLAS JET, MINISTRY OF HEALTH AMBULANCE, GENERAL AVIATION, TDTEAM, FREEBIRD, III. LANDAIR AVIATION, UNVER AVIATION, AND THK AGENCY 's to be given chemical sales service Our company is in talks with Turkish Airlines airline başlanmıştır. mill, briefings and field demonstration work is done during the sales process is blocked.

Our company is currently serving the above-mentioned airline and aviation maintenance company adds new products to its portfolio every day.

Business plans "innovative service beyond expectations" that make up our company with the vision, corporate strategy "for the customers' needs, technological, safe, and providing innovative solutions" has been built in the target. Our organization is a company in the industry with the widest reliable and brand new technological and service network

NCAGE : TB246
NSN : 6850270444096
PARÇA NO : SK11755



JAN EX APC CLEAN CLEANING LIQUID FOR AVIATION VEHICLES

Water-based cleaning detergent. Cleans easily Petroleum derivative oils, smut and soot

Not creating any color loss since not effecting original epoxy -based aircraft paints. Biodegradable and environment-friendly product. Produced according to MIL - C 85570 (type 2) standards to wash/clean aircraft and helicopters. Can be used in the high pressure and steamy machines. Rust preventive inhibitors are included.

Usage Areas :

Can be used outer surfaces of aircraft and helicopter bodies safely. Additionally, can be used safely to clean any surface where water contact is not problem. However, aircraft's cockpit and other glasses should be screened.

Expected cleaning is achieved at areas where exhaust dirt is main problem(eg.hooks) with the strong formula.

Usage ratio :

Aircraft and helicopter	
Outer body cleaning	1 : 5 - 1 : 20
As a general cleaner	1 : 10 - 1 : 50

Ratios can be diluted with hot or cold water. Application is executed via brush from down to up after cleaning the heavy dirt to the bodies of aircraft and helicopter.

Preventive actions:

- Read instruction manual before usage.
- Keep away from the kids.
- Do not use for food cleaning.
- Wash with water awfully in case of eye(s) contact.

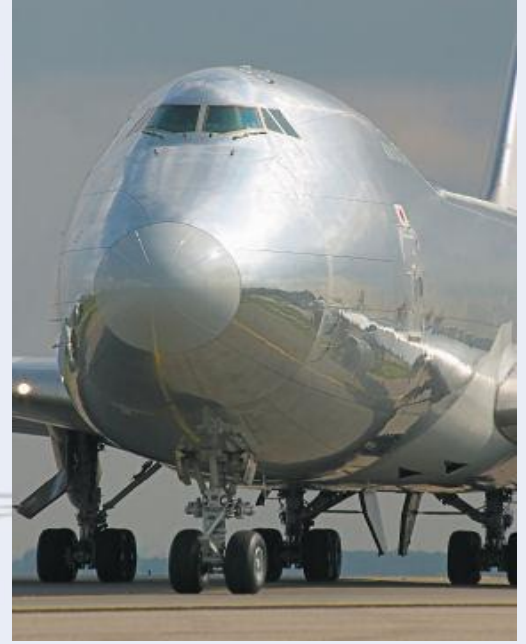

NCAGE	: TB246
NSN	:
6850270444096	
PARÇA NO	: SK11755

JAN SS EX-OIL

WATER BASED INDUSTRIAL HEAVY DIRT & OIL RESOLVENT

JAN SS EX-OIL is a water-based detergent solvent. Cleans “animal, vegetable and petroleum derivative oils” easily without rinse with consanrated & powerful formula.
Can be used for general purpose cleaning via diluting with sweet or salty water.
It is not flammable and flashing.
Biodegradeable and environment-friendly product.

Can be used in the high pressure and steamy machines.
Multipurpose product can be applied in many areas to clean dirt, oil and spot. Cleans without rinsing. Cleaning can be via brush, splashing or spraying. Can be diluted via sweet or salty water; having advantage at storage.
Has economic benefits since can be diluted with high ratio of water.
Rust preventive inhibitors are included.
Not flammable.

Usage ratios:

According to dirt level of the surfaces;

Heavy grease and oil resolvent	1 : 1
Normal grease, oil and spots	1 : 3
Heavy cleaning at painted surfaces	1 : 20
Painted surface before repainting	1 : 5 - 1 : 8
Spot removal at painted surfaces	1 : 5 - 1 : 12
Oil removal before painting (cold)	1 : 8 - 1 : 15
Filters, HVAC channels and chimney	1 : 5 - 1 : 20
Heavy construction equipment & car cleaning	1 : 12 - 1 : 25
Oil removal before painting (hot 60 C)	1 : 30 - 1 : 50

Apply via brush, splash or spraying to the cleaning area.

Preventive actions:

- Read instruction manual before usage.
- Keep away from the kids.
- Do not use for hand, face, body and food cleaning.
- Wash with water if touched your skin.
- Wash with water awfully and apply your doctor in case of eye(s) contact.
- Use preventive tools (eg.gloves, glass/mask,) during application.

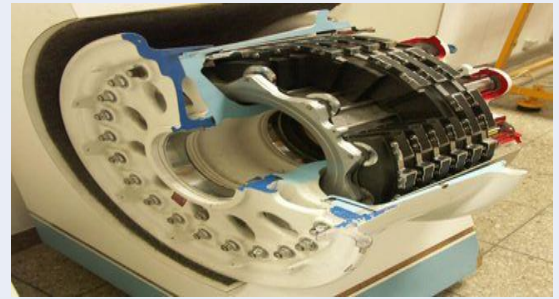
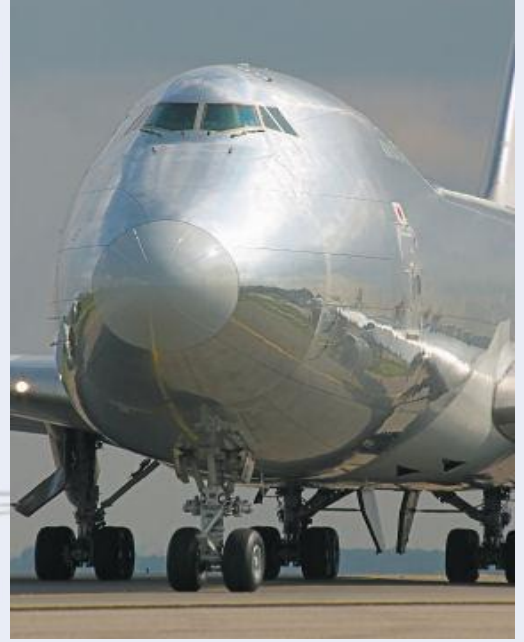

NCAGE : TB246
NSN :
6850270514932
PARÇA NO : SKI1355

JAN SS EX OIL A1380- CIC, WAX AND GREASE REMOVER Thixotropic Wax and Grease Remover

JAN SS EX OIL A1380 is VOC free solvent that removes CIC s, TPC s, oils and greases from aircraft surfaces.

JAN SS EX OIL A1380 is an emulsifiable and thixotropic solvent. The controlled viscosity gives good adherence on surfaces while permitting increased contact time with the soils or the coatings to be removed. The product may be easily rinsed off with pressurised water. It is not subject to classification under the European legislation on VOCs (Directive 1999/13/CE).

JAN SS EX OIL A1380 may be used for all aircraft surfaces- landing gear, undercarriage bays, wheels, and holds. Inert on ferrous metals and light alloys, painted or non painted. No embrittlement on high tensile steel.

JAN SS EX OIL A1380 removes waxy and oily temporary protective coatings, tenacious oils and hardened greases on landing gear, undercarriage bays, wheels, and holds.

Use

Cleaning and degreasing of tenacious soils on aircraft structures or components, perfectly fitted for removing CIC, oil or wax-like temporary protective coatings

DIRECTIONS FOR USE

JAN SS EX OIL A1380 can be applied by dipping, brushing, airmix or airless spraying.

Spray the product onto the surface to give a 30 to 120 μ film - dwell time: between 20 and 60 minutes depending on the CIC thickness to be removed and the temperature.

If necessary, renew the application.

Finally rinse with hot water by means of a high pressure machine (50-120 bars).



JAN SS EX OIL A1380
CIC, Wax And Grease Remover
NCAGE : TB246
PARÇA NO : SK11380

JAN ENG CLEAN P-D-680 TYPE II DEGREASING SOLVENT

MIL PRF 680-C (Military Symbol SD-2)

Not contains aromatic solvents, not abrasive and nor leaves residual.

More safe compared to Gasoline, Gasoil and Tricloretilen.

Not easy flammable and works speedy during cleaning and less evaporate.

Used especially at aviation industry, tire workshops and ball bearing cleaning processes .

Effects speedy compared to other cleaners.

Can be used to clean any part, which should be lubricated.

Technical Data :

Specific gravity : 0,88

Flash point : over 68°C

Tag Closed Cup. Boiling range: 188 - 200°C.

Shelf Life : 3 Years Minimum

Safety :

Flammable, NON-Abrasive. Our slogan says it all. products are formulated as Biodegradable, made safe for cleaning.

Preventive actions:

- Read instruction manual before usage.
- Keep away from the kids.
- Do not use for food cleaning.
- Wash with water awfully in case of eye(s) contact.

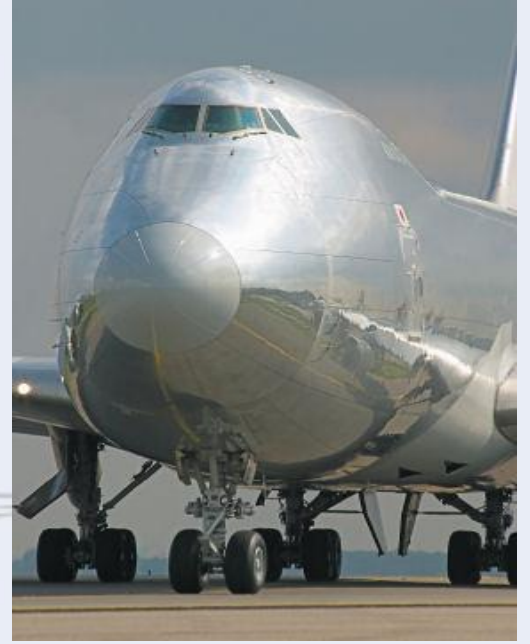

NCAGE	: TB246
NSN	: 6850270515169
PARÇA NO	: SK12155

ACETONE (dimetil keton and 2-propanon) (ASTM D 329-07 ACS 10th addition reagent grade)

Strong and fast acting Acetone is a highly effective thinner and remover for polyester and epoxy resins, inks, adhesives, joint sealings and other specified coatings. It thins and cleans the glass fiber resins, which is an effective cleaning solvent for glass fiber projects. Acetone will also clean glass fiber resins and foreign materials. The solvent evaporates quickly, does not leave residue, and cleans dried latex paint, hardened lacquer and label adhesives. It is a clear, colorless, low boiling point, flammable, volatile liquid characterized by rapid evaporation and a slightly aromatic odor. Most organic solvents can easily mix and mix with water everywhere.

Preventive actions:

- Read instruction manual before usage.
- Keep away from the kids.
- Do not use for food cleaning.
- Wash with water awfully in case of eye(s) contact.



NCAGE	: TB246
NSN	:
PARÇA NO	: SK12157

METHYL ETHYL KETONE (MEK)

Type I Regular Grade (2-butanone) Type II Urethane Grade ASTM D 740-05 USP24 and ACS 9th addition

Polyester and epoxy resins are a thinner for specified coatings, including inks, adhesives. It is recommended to use a slower evaporation rate from acetone when requested. It is an important, low-cost solution similar to acetone. It is used as a cleaning material to prepare a surface for painting and as a cleaner for certain surfaces. It cleans the wax and grease from the surface and is used in engine parts around ignition and carburement systems for cleaning and removing carbon.

Preventive actions:

- Read instruction manual before usage.
- Keep away from the kids.
- Do not use for food cleaning.
- Wash with water awfully in case of eye(s) contact.



NCAGE	: TB246
NSN	:
PARÇA NO	: SK12156

İZOPROPİL ALKOL (IPA % 99) ASTM D 770-11 TT-1-735A GRADE A DIN 53245 ACS 8th addition

Isopropyl alcohol 99% is a general purpose cleaning and degreasing solvent for use in many applications. The rapid evaporation rate of this product helps to clean grease, oil, dust and smudge. It is usually used for wiping, rinsing or spray applications. Perfect for part cleaning and paint preparation.

Preventive actions:

- Read instruction manual before usage.
- Keep away from the kids.
- Do not use for food cleaning.
- Wash with water awfully in case of eye(s) contact.



NCAGE	: TB246
NSN	:
PARÇA NO	: SK12152

JAN GUM REMOVER GUM STAIN REMOVER FOR CARPET SURFACE

A high-performance essential oil, adhesives, tar, gum, oil-based paint and carpet and fabric stains difficult to resolve on solving many general-purpose solvent-based cleaning product.

Usage Areas :

All kind metals, plastic, fabric, carpet and decks of glue, mastic and out of tough spots tape Easily cleans the surface, without damage. Applied on the surface does not leave now. Prevents sticking around, disturbing the structure and distribution of hardened spots.

Usage ratio :

Used as Direct.
Textiles is an invisible part of the pre-trial.
Sprayed onto the stain, are expected for a while.
If necessary, lightly brushed with a brush.
With a clean cloth will be deleted.
If necessary, re-applied.

Preventive actions:

- Corrosive, irritant-free.
- Falling on hands, face, body in constant contact, wash with water.
- Highly flammable..

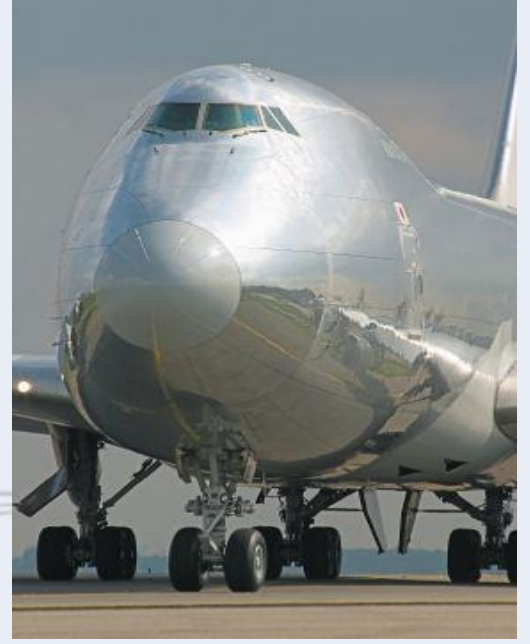

NCAGE	: TB246
NSN	:
PARÇA NO	: SK13055

JAN SS WC SHINE INDUSTRIAL WC BATH CLEANER

Lavatory and toilet cleaning concentrate.
Biodegradable, environmentally friendly

Usage Areas :

- . Germicidal solution effective in removing stains, descaling toiletbowls and waste line system.
- . Ideal for in-place localized cleaning. Applicable on stainless steel, aluminium and Teflon coated toilet bowls,
- . Environment friendly, Biodegradable, fully miscible in water.
- . Worker safe does not emit harmful toxic fumes,
- . Thixotropic, Non-flammable, Frost resistant..

Usage ratio :

Flush the toilet & squirt under the rim and all around the bowl
Let soak for a few minutes
Lightly scrub & flush again

Preventive actions:

- Corrosive, irritant-free.
- Falling or hands, face, body in constant contact, wash with water.
- Avoid contact with eyes, do not ingest. If swallowed, drink water and contact your physician.

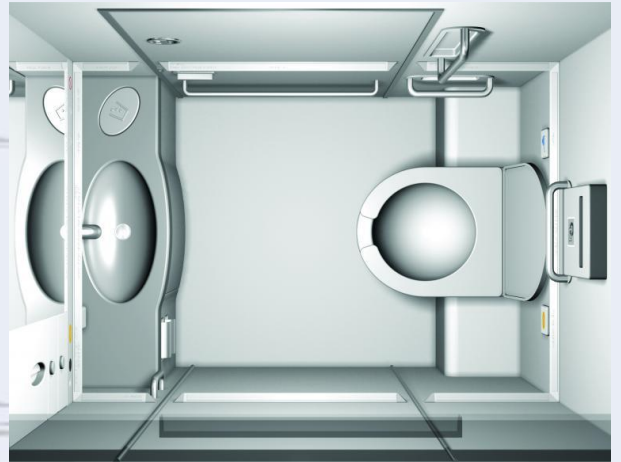
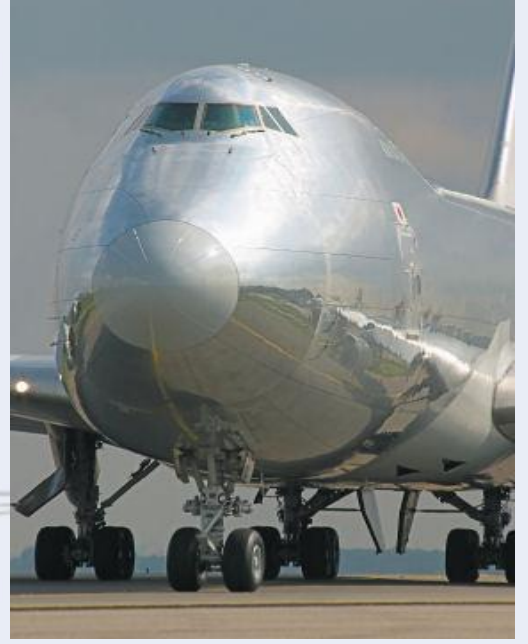

NCAGE	: TB246
NSN	:
PARÇA NO	: SK29545

JAN SS 208 P FG VINEGAR WHITE TECHNICAL Disinfectant with deodorant for removal of scale deposits in aircraft toilet lines

Vinegar has an acidity of 2.5 to 4.0 on the pH scale . The acidity of vinegar helps to dissolve soil particles by making them charged. These newly charged soil particles become attracted to the positive and negative charges in water. The soil is pulled into the water by strong intermolecular electrostatic forces and thus can be easily removed . Vinegar is extremely helpful in places with shower head corrosion, toilet bowl stains, soap scum build-up, and various other mineral surface deposits. Vinegar can also be used to clean up the dark green and black inorganic coating that develops on copper and brass metals, which are often used for cooking utensils and jewelry .

Usage Areas :

Vinegar White Technical is an acidic industrial cleaner. Vinegar has been used for removal of scale deposits in Aircraft toilet lines. A mixture of Vinegar and crushed ice is used to flush through the lines as required by the Airline maintenance procedures.

Vinegar is also a natural alternative product used as a cleaner deodoriser throughout the home.

Vinegar may be used on laundry, carpets, floors, bathrooms, kitchen areas, grout and cleaning tools.

SORF Chemicals here by certifies that the above referenced material conforms to all requirements under ; Boeing D6-7127 revision P specifications and all standard quality control checks performed during manufacture and prior to delivery.



Preventive actions:

- Read instruction manual before usage.
- Keep away from the kids.
- Do not use for food cleaning.
- Wash with water awfully in case of eye(s) contact.

NCAGE	: TB246
NSN	:
PARÇA NO	: SK10208

JAN SS PR SO 9 OVEN CLEANER

It contains many special characteristics thanks to extremely powerful, effective and safe oven cleaner. Strong surfactants burned through, even in intensive oil and cold surfaces get you the most effective solution.

Usage Areas :

Because of that Thixotropic (The liquid product packaging, oily surface sprayed on gelation) provides more cleaning in a very small amount of usage will not wash away on vertical surfaces, surface clinging to the cleaning will be performed more economically and in a short time.

Usage ratio :

- . Spray the inside of the oven
- . Wipe again with a cloth, wait 5-10 minutes.

Preventive actions:

- Contains Sodium Hydroxide. Extremely flammable. Causes severe burns. Irritating to respiratory system.
- Falling or hands, face, body in constant contact, wash with water.
- Avoid contact with eyes, do not ingest. If swallowed, drink water and contact your physician.

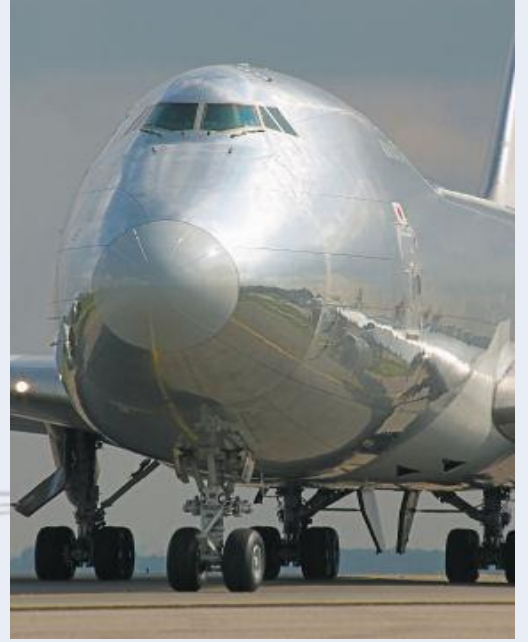

NCAGE	: TB246
NSN	:
PARÇA NO	: SK24375

JAN ENDURO CREAM CREAM PASTE HAND CLEANER

Of employees in the maintenance department technicians degreaser soap used to clean heavy grease and dirt in their hands. Heavy dirt and grease lanolin added concentrated liquid soap does not crack in winter thanks to lanolin in hand remover soap concentrate content

Pumice ingredient cleans and protects gently and thoroughly
Special Dermatin skin protection ingredient regenerates the skin while preventing irritation
Environmentally friendly
Free of alkali and silicone oil
Pleasant smell

Usage Areas :

Oil, grease, fat and more – it's easy to get your hands dirty when you work.

Usage ratio :

From a soap dispenser, a quantity taken handwashing with soap or two printing pastes. Rubbing hands beautifully. Rinse with plenty of water.

Preventive actions:

- . There is no risk to human health
- . Biodegradable part in nature (84 active) are produced from raw materials.

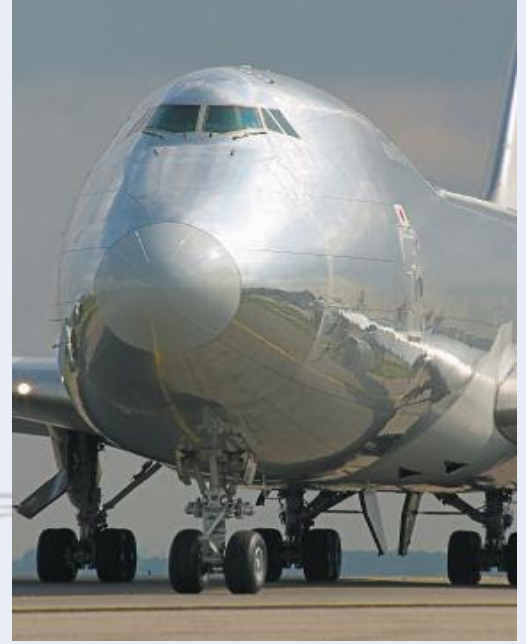

NCAGE	: TB246
NSN	:
PARÇA NO	: SK29475

JAN EX ICING AMS 1435 RUNWAY DE ICING ANTIICING FLUID

RUNWAY DE ICING AND ANTI ICING FLUID

It is a chemical solution that prevents the snow from getting on the road surface and prevents freezing and icing.

It is snowing and applied before the tip.

Anti-freeze feature prevents icing.

It remains on the road surface in a thin layer that prevents the snow from catching.

Even in heavy traffic, you must stay on the road to absorb the wetness

Environment friend, fertilizer for plants.

Long life, easy to apply in a short time, both labor and time savings

Since it does not contain abrasive material, it is important not to damage the asphalt, concrete and metal hitches.

Effective even at very low temperatures. (Up to -60°C).

PREVENTIVE ACTIONS

Read instruction manual before usage.

Keep away from the kids.

Do not use for food cleaning.

Wash with water awfully in case of eye(s) contact.



**RUNWAY DE ICING ANTIICING
AMS 1435
NCAGE : TB246
PART NO : SK10283**



SÖRF KİMYA

İNŞ. TAAH. TUR. GIDA ve TEMİZLİK ÜR.
SAN. TİC. İTH. İHR. LTD. ŞTİ.

A.O.S.B. 8282 Sokak No.32 Çiğli - İZMİR

Tel: (0232) 386 33 30 Fax: (0232) 329 44 00 e-mail: info@sorfkimya.com www.sorfkimya.com